

# jWIN

## CD MICRO SYSTEM



## Instruction Manual

**JX-CD7160**

Please read this manual carefully before operating and save it for future reference.

**Have a question? Please visit <http://www.jWIN.com>**

## USER SAFETY GIUDE

### IMPORTANT SAFETY INSTRUCTIONS

**WARNING:** To prevent fire or shock hazard, do not expose this appliance to rain or moisture.



**CAUTION**  
**RISK OF ELECTRIC SHOCK**  
**DO NOT OPEN**



These markings are located on the bottom, side or back of the unit.

**CAUTION:** To prevent the risk of electric shock, do not remove cover (or back). Non-user-serviceable parts inside. Refer servicing to a service professional.

- The lightning flash with an arrowhead symbol, within an equilateral triangle, is intended to alert the user to the presence of un-insulated "dangerous voltage" within the product's enclosure that may be of sufficient magnitude to constitute a risk of electric shock to a person.
- The exclamation point within an equilateral triangle is intended to alert the user to the presence of important operating, maintenance and servicing instructions in the literature accompanying the appliance.

**Dripping warning:** "This product shall not be exposed to any dripping or splashing, and no objects filled with liquids, such as vases, shall be placed on or near the product."

**Ventilation warning:** "The normal ventilation of the product shall not be impeded for intended use." (Minimum distances must be kept around the apparatus for sufficient ventilation, especially while use of the apparatus is in tropical and/or moderate climates.)

|  |                                                                                                                                                                                                                                                                                                                                                                                                                                                                                                                                                                                                   |
|--|---------------------------------------------------------------------------------------------------------------------------------------------------------------------------------------------------------------------------------------------------------------------------------------------------------------------------------------------------------------------------------------------------------------------------------------------------------------------------------------------------------------------------------------------------------------------------------------------------|
|  | <p>Dispose of old batteries safely. <b>Do not throw them into a fire.</b></p>                                                                                                                                                                                                                                                                                                                                                                                                                                                                                                                     |
|  | <p><b>LASER SAFETY</b><br/> This unit utilizes laser technology. Only a qualified professional should remove the cover or attempt to service this device, due to possible eye injury.</p> <p><b>CAUTION</b></p> <ul style="list-style-type: none"> <li>• Use of controls or adjustments or performance of procedure other than specified herein may result in hazardous radiation exposure.</li> <li>• Hazardous laser radiation when open and interlock defeated.</li> </ul> <p><b>DANGER</b><br/> Invisible laser radiation when open and interlock failure. Avoid direct exposure to beam.</p> |

## USER SAFETY GIUDE

### INSTRUCTIONS ON ENVIRONMENT PROTECTION

Do not dispose of this product in the usual household garbage at the end of its life cycle; bring it to a collection point for the recycling of electrical and electronic appliances. This symbol on the product means the instructions for use or the packing will inform about the methods for disposal. The materials are recyclable as mentioned in its marking. By recycling, material recycling, or other forms of re-utilization of old appliances, you make an important contribution to protect the environment. Please inquire at your local community administration for the authorized disposal location.



### IMPORTANT SAFETY PRECAUTIONS

1. **READ INSTRUCTIONS** - All safety and operating instructions should be read before the appliance is operated.
2. **RETAIN INSTRUCTIONS** - The safety and operating instructions should be retained in a secure place for future reference.
3. **HEED WARNINGS** - All warnings on the appliance and in the operating instructions should be observed.
4. **FOLLOW INSTRUCTIONS** - All operating and use instructions should be followed.
5. **WATER AND MOISTURE** - The appliance should not be used near water. For example: near a bathtub, kitchen sink, laundry tub, and swimming pool or even in a wet basement.
6. **VENTILATION** - The appliance should be situated so that its location and position does not interfere with its proper ventilation. For example, the appliance should not be situated on a bed, sofa, rug or similar surface that may block the ventilation openings; or, be placed in a built-in installation, such as a bookcase or cabinet that may impede the flow of air through the ventilation openings.
7. **HEAT** - The appliance should be situated away from heat sources such as radiators, heat registers, stoves, or other appliances (including amplifiers) that produce heat.
8. **POWER SOURCES** - The appliance should be connected to a power supply only of the type described in the operating instructions or as marked on the appliance.
9. **GROUNDING AND POLARIZATION** - Precautions should be taken to ensure that the grounding or polarization of the appliance is correct.
10. **POWER CORD PROTECTION** - Power supply cords should be routed so that they are not likely to be walked on or obstructed by items placed upon or against them. Pay particular attention to cords at plugs, convenience receptacles, and the point at which they exit from the appliance.
11. **CLEANING** - The appliance should be cleaned only as recommended by the manufacturer.
12. **POWER LINES** - An outdoor antenna should be located away from power lines.
13. **NONUSE PERIODS** - The power cord of the appliance should be unplugged from the outlet when the appliance is to be left unused for an extended period of time.

## USER SAFETY GIUDE

### IMPORTANT SAFETY PRECAUTIONS – CONTINUED

14. **OBJECT and LIQUID ENTRY** - Care should be taken so that objects do not fall and liquids are not spilled into the device's openings.
15. **CARTS AND STANDS** - The appliance should be used only with a cart or stand that is recommended by the manufacturer. An appliance and cart combination should be moved with care. Quick stops, excessive force, and uneven surfaces may cause the appliance and cart combination to overturn. 
16. **WALL OR CEILING MOUNTING** - If the appliance is mounted to a wall or ceiling, it should be mounted only as recommended by the manufacturer.
17. **DAMAGE REQUIRING SERVICE** - The appliance should be serviced by qualified service professional when:
  - a. The power-supply cord or plug has been damaged.
  - b. Objects have fallen into, or liquid has been spilled into the appliance's apertures.
  - c. The appliance has been exposed to rain.
  - d. The appliance has been dropped and suffered damage.
  - e. The appliance does not appear to operate normally or exhibits a marked change in performance.
18. **SERVICING** - The user should not attempt to service the appliance beyond that described in the user's operating instructions. All other servicing should be referred to qualified service professional.
19. **PROTECTIVE ATTACHMENT PLUG** - The appliance is equipped with an attachment plug that has an overload protection. This is a safety feature. If replacement of the plug is required, be sure the service technician has used a replacement plug specified by the manufacturer that has the same overload protection as the original plug. (UK Version Only)

### FCC NOTICE (USA)

This device complies with Part 15 of the FCC Rules. Operation is subject to the following two conditions: (1) this device may not cause harmful interference, and (2) this device must accept any interference received, including interference that may cause undesired operation.

**FCC regulations state that any change or modification to the equipment, not expressly approved by maker or its authorized parties, could void user's authority to operate this equipment.**

- To prevent fire or electric shock, do not expose the unit to rain or moisture.
- Never attempt to open the cabinet. Dangerous high voltages are present in the unit. Always refer servicing to a qualified technician.

### IC NOTICE (CANADA)

This digital apparatus does not exceed the Class B limits for radio noise emissions from digital apparatus as set out in the Radio Interference Regulations of Industry Canada.

## TABLE OF CONTENTS

|                                                           |    |
|-----------------------------------------------------------|----|
| <b>1. Getting Started</b>                                 |    |
| a. Introduction .....                                     | 5  |
| b. Location of Controls (top, speaker, right, left) ..... | 6  |
| c. Location of Controls (Back Panel) .....                | 7  |
| d. Location of Controls (Remote) .....                    | 7  |
| e. Connecting the Speakers .....                          | 8  |
| f. AC Operation .....                                     | 8  |
| g. Antennas .....                                         | 8  |
| h. Listening with Stereo Headphones .....                 | 8  |
| i. Installing the Batteries in the Remote Control .....   | 8  |
| <b>2. Operational Instructions</b>                        |    |
| a. Loading a CD into the Player .....                     | 9  |
| b. Listening to CDs .....                                 | 9  |
| c. Repeat Mode .....                                      | 10 |
| d. Skip and Search Mode .....                             | 10 |
| e. Program Mode .....                                     | 10 |
| f. Listening to the Radio .....                           | 11 |
| g. FM Stereo Indicator .....                              | 11 |
| h. Bass Boost .....                                       | 11 |
| <b>3. Maintenance &amp; Specifications</b>                |    |
| a. Notes on CDs .....                                     | 12 |
| b. Cleaning the lens .....                                | 12 |
| c. Cleaning the cabinet .....                             | 12 |
| d. Troubleshooting.....                                   | 13 |
| e. Technical specifications .....                         | 14 |

## GETTING STARTED

Thank you for purchasing the JX-CD7160. Unpack the unit and make sure to put aside all accessories so they will not be lost. We recommend that you retain the original carton and packaging materials for future use, should you transport or ship the unit in the future.

### Portable stereo audio system

- CD top loading mechanism
- Detachable satellite speakers
- Programmable memory for 20 audio tracks
- Supports repeat, skip and search functions
- Liquid crystal display (LCD) for CD playback and AM / FM Radio Display
- Dynamic bass boost system (DBBS)
- Built-in AM / FM stereo radio
- Playable Media: Audio CD (CD-R / CD-RW)
- Total audio output: 2.0W<sub>RMS</sub> / Channel

### What's included

- CD mini system
- Remote control
- Instruction manual



## GETTING STARTED

### Location of Controls (top, speaker, right, left)

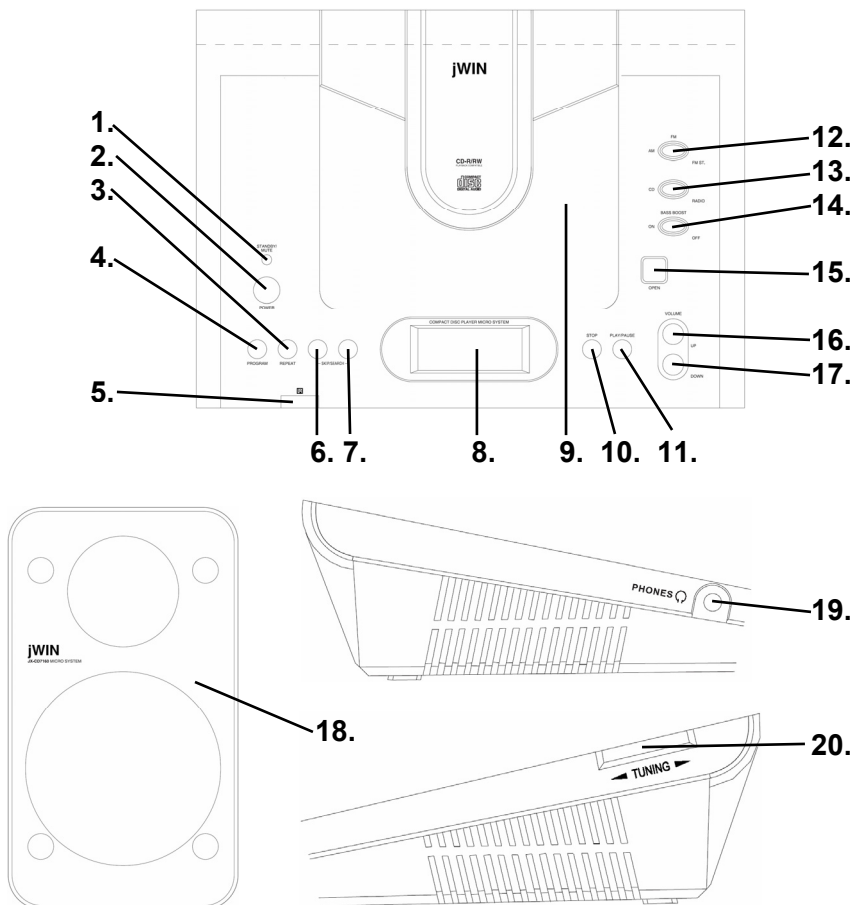

1. STANDBY/MUTE LED INDICATOR
2. POWER BUTTON
3. CD REPEAT BUTTON
4. CD PROGRAM BUTTON
5. REMOTE CONTROL SENSOR
6. CD SKIP/SEARCH BACKWARD BUTTON
7. CD SKIP/SEARCH FORWARD BUTTON
8. LCD SCREEN
9. CD COMPARTMENT DOOR
10. CD STOP BUTTON

11. CD PLAY/PAUSE BUTTON
12. BAND SWITCH (AM, FM, FM ST.)
13. FUNCTION SWITCH (CD/RADIO)
14. BASS BOOST SELECTOR
15. CD DOOR-OPEN BUTTON
16. VOLUME UP BUTTON
17. VOLUME DOWN BUTTON
18. STEREO SPEAKER (LEFT AND RIGHT BOTH INCLUDED WITH UNIT)
19. STEREO HEADPHONE JACK
20. TUNING KNOB

# GETTING STARTED

## Location of Controls (back)

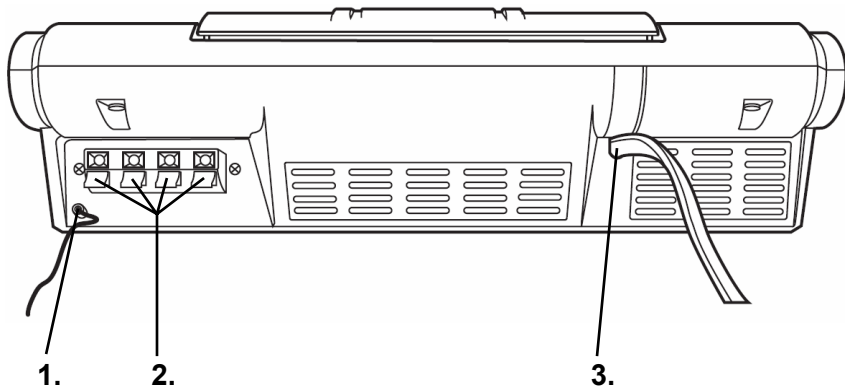

- 1. FM ANTENNA CONNECTION
- 2. SPEAKER TERMINALS
- 3. AC CORD CONNECTION

## Location of Controls (Remote Control)

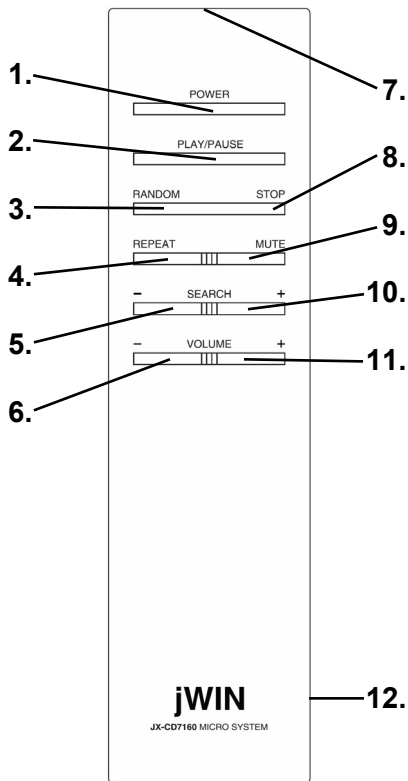

- 1. POWER BUTTON
- 2. PLAY/PAUSE BUTTON
- 3. RANDOM BUTTON
- 4. REPEAT BUTTON
- 5. SEARCH - BUTTON
- 6. VOLUME - BUTTON
- 7. INFRARED SENSOR (TOP)
- 8. STOP BUTTON
- 9. MUTE BUTTON
- 10. SEARCH + BUTTON
- 11. VOLUME + BUTTON
- 12. BATTERY DOOR (REAR)

**Note:** For best results, point the infrared transmitter on the remote control directly at the remote sensor on the main unit.



## GETTING STARTED

### Connecting the Speakers

Connect the **SPEAKER** cables to the **SPEAKER** terminals in the rear of the unit properly.

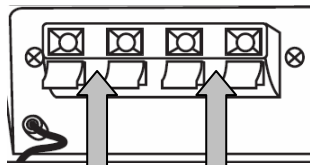

### AC Operation

Before operating this unit, make sure the voltage indicated on the JX-CD7160 matches the voltage in the wall outlet.

1. Plug the **AC POWER CORD** into a standard AC wall outlet.

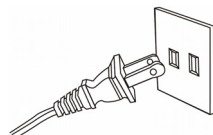

STANDBY/  
MUTE



2. The **STANDBY/MUTE INDICATOR** will light.

3. Press the **POWER** button. The **LCD DISPLAY** will light and the **STANDBY/MUTE INDICATOR** will go off.

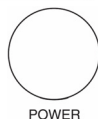

### Antennas

For best FM reception, fully extend the FM antenna. For AM reception, this unit has a built-in antenna.

### Listening with Stereo Headphones

For private listening, insert the 3.5mm plug of a stereo headphone set (not included) into the **STEREO HEADPHONE JACK** on the left side panel of the JX-CD7160. Volume on the headphones is controlled by the **VOLUME** knob on the unit of the **VOLUME +/-** button on the remote control. When headphones are used, sound on the external speakers cuts off.



**Note:** Be sure that your headphones have an impedance of 32ohms.

### Installing Batteries in the Remote Control

1. Slide open the **BATTERY DOOR** in the direction of the arrow imprinted on the door itself.
2. Install two (2) AA size batteries according to the polarity (+/-) marked inside the compartment.
3. Close the **BATTERY DOOR**.

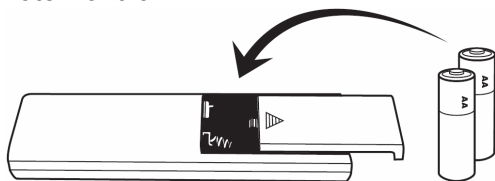

**Note:** Remote Control buttons correspond with the similarly labeled buttons on the main unit. The recommended distance for remote operation is 16 feet or less.

## OPERATIONAL INSTRUCTIONS

### Loading a CD into the Player

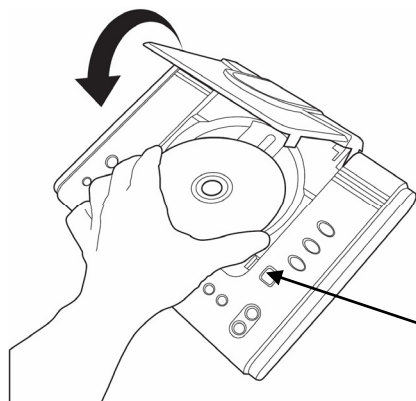

1. Press the **OPEN** button on the front of the unit to open the CD compartment.
2. Place a CD into the compartment with the label facing up and close the CD door.

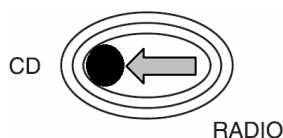

3. Set the **FUNCTION** switch to CD.
4. The total number of tracks on the CD will appear on the LCD display.
5. When the **FUNCTION** switch is in the CD position and there is no disc inside, the LCD display will show "00" and remain in the **STOP** mode.

### Listening to CDs

1. In the **STOP** mode, press the **PLAY/PAUSE** button to begin playback. The first track on the CD will play. The **PLAY** indicator and the number of the track playing will appear on the LCD display.

PLAY/PAUSE



2. Press the **PLAY/PAUSE** button once to pause the playback. The **PLAY** indicator will flash while the music is paused.

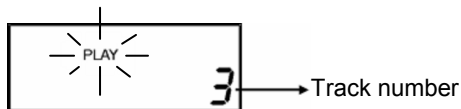

3. Press the **PLAY/PAUSE** button again to resume playback from the same position where it was stopped.
4. Press the **STOP** button stop playback.
5. Press the **POWER** button once to turn off the unit. The LCD light will go off and the **STANDBY/MUTE** LED indicator will light.

## OPERATIONAL INSTRUCTIONS

### Repeat Mode

1. Press the **REPEAT** button once to enter the **REPEAT 1** mode.
2. The **REPEAT** indicator will light and flash continuously. A single CD track will be repeated.

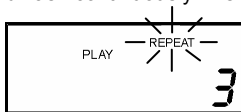

3. Press the **REPEAT** button twice to enter the **REPEAT ALL** mode.
4. The **REPEAT** indicator will now display constantly. The entire disc will now repeat continuously.

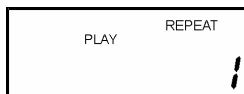

5. To exit **REPEAT** mode, press and hold the **REPEAT** button until the **REPEAT** indicator goes off.

### Skip and Search Mode

1. Press the **SKIP FORWARD** (▶▶) or **SKIP BACKWARD** (◀◀) button once during **PLAY** or **PAUSE** mode to skip to the next track or return to the beginning of the current track.



2. Press and hold the **SKIP FORWARD** (▶▶) or **SKIP BACKWARD** (◀◀) button during the **PLAY** or **PAUSE** mode to search the tracks with audible high-speed forward or backward playback.

### Program Mode

1. Press the **PROGRAM** button once to enter the **PROGRAM** mode.

2. The **PROGRAM** indicator will light and blink continuously.

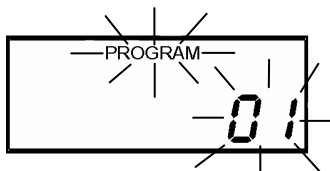

3. The number of programs (beginning at **01**) to memorize will also appear on the LCD display blinking continuously.

4. Press the **SKIP FORWARD** (▶▶) or **SKIP BACKWARD** (◀◀) button to find the desired track.

5. When the desired track number appears on the LCD display, press the **PROGRAM** button to store the track into memory (ie. Track 7).

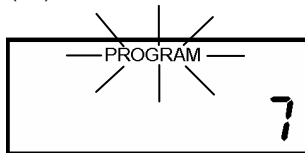

6. Press the **CD STOP** button or open the CD door during the **STOP** mode to cancel the **PROGRAM** mode. The **PROGRAM** indicator will disappear from the LCD screen.

## OPERATIONAL INSTRUCTIONS

### Listening to the Radio

- Slide the **FUNCTION** switch to the **RADIO** position.

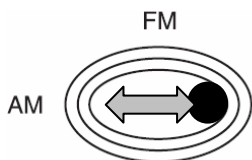
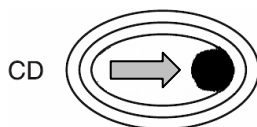

- Slide the **BAND** switch to the desired waveband (AM, FM or FM ST.).

FM ST.

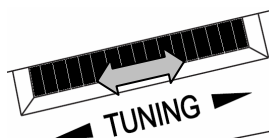

- Turn the **TUNING** knob to the desired radio station (appears on the LCD display).

- Adjust the sound level using the **VOLUME (+/-)** control.

- To turn off the radio, press the **POWER** button once. Until the LCD display goes off and the **STANDBY/MUTE** LED indicator goes on.

### FM Stereo Indicator

Slide the BAND switch to FM ST. When listening to an FM station with strong reception, this function will allow it to broadcast in stereo. When the FM signal is weak, slide the switch to the FM position.

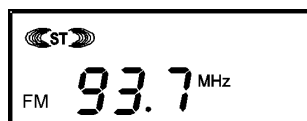

### Bass Boost

To enhance the low frequency sound, slide the **BASS BOOST** switch to the **ON** position. To release the super bass, slide the **BASS BOOST** button to **OFF**.

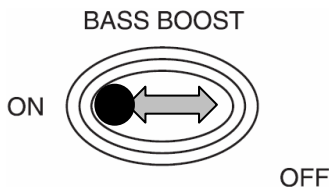

## MAINTENANCE

### Notes on CDs

1. Before playing, clean the CD with a cleaning cloth. Wipe the CD from the center out to the ends.
2. Do not use solvents such as benzene, thinner, commercially available cleaners or anti-static spray intended for vinyl LPs.
3. Do not expose the CD to direct sunlight or heat sources such as hot air ducts. Do not expose to direct sunlight, nor leave CDs in a car, as there can be a considerable rise in temperature.
4. Do not stick paper or sticker on the CD. Do not scratch, dirt or fingerprints on the CD, for it may cause tracking error.

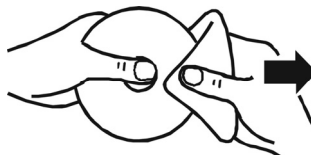

### Cleaning the lens

If the lens becomes dirty, it may cause a skipping of sound during CD operation. Clean with a commercially available lens cleaner.

### Cleaning the cabinet

Clean the cabinet, panel and controls with a soft cloth slightly moistened with a mild detergent solution. Do not use any type of abrasive pad, scouring powder, or solvent, such as alcohol or benzene.

## TROUBLESHOOTING GUIDE

When the instructions in this manual are followed, this unit should function properly. However, if any of the following difficulties occur and cannot be corrected by the user or if a problem arises that is not mentioned here, please contact jWIN Customer Service or a qualified service technician.

1. Unit Does Not Play
  - Unit may be disconnected from power source. Check connection.
  - Disc is not correctly set. CDs should be inserted label side up.
  - Disc is scratched or dirty. Please clean.
  - The lens is dirty. Wipe clean gently with soft, dry cloth. Follow the instructions of the lens cleaner.
  - There is moisture on the lens wait an hour and try again.
2. No Sound, Distorted Sound or Feedback
  - Ensure plugs are inserted firmly.
  - Wipe off plugs with clean cloth.
  - Disc is scratched or dirty. Please clean.
  - Volume control is turned down. Please increase.
3. Sound from Only One Side (or inverted)
  - Speaker cords are not properly connected.
  - Input cords are not properly connected.
4. Radio Reception is Unclear
  - Radio station frequency may be weak. Adjust antenna.
  - If FM station, **BAND** switch may be set to **FM ST**. Slide **BAND** switch to **FM**.

## SPECIFICATIONS

- Audio Output: 2.0W RMS/ Channel
- Frequency Range
  - AM: 530kHz – 1710kHz
  - FM: 88MHz – 108MHz
- Connectivity
  - 3.5mm stereo headphone jack
- Power Requirement
  - Main Unit: AC 120V / 60Hz
- Power Consumption:  $\leq 15W$
- Main Unit Dimensions (W x H x D): Approx. 290 mm x 82 mm x 220 mm
- Speaker Dimensions (W x H x D): Approx. 120 mm x 212 mm x 150 mm
- Unit Weight: Approx. 3.75 lbs (1.7 kg)

\* Specifications and features are subject to change without prior notice.

# **jWIN**

**TEL: 516-626-7188**

**FAX: 516-626-7105**

**website: [www.jWIN.com](http://www.jWIN.com)**

© 2007 jWIN Electronics Corp. All rights reserved. No portion of this printed material or product enclosed herewith including design, shape and graphics, may be reproduced or transmitted in any form without prior written consent of jWIN Electronics Corp. by any means, electronic or mechanical, including photocopying, recording or use of an information storage and retrieval system. Any unauthorized distribution or reproduction of this printed material or product, or any portion thereof, will be prosecuted to the fullest possible extent of the law.

Printed in China